

■ Wet Room Solutions







Index

Polyflor Wet Room Products	4
Installation of Wet Area System	7
Installation of Floor Covering	10
Installation of Vinyl Wall Sheet	12
Installation Drawings	14
Technical Support Data	19
Installation Instructions	25
Floor & Wall Care Instructions	32

■ Introduction

The Polyflor Wet Room System was created to offer a practical and hygienic alternative to traditional bathroom and wet area finishes.

New and older buildings often suffer from differential movement caused by sub strait settling that can leave ugly cracks and imperfections creating ideal conditions for the growth of harmful bacteria and mould. Some movement can also lead to water leaking into the substrate causing structural damage over time.

Polyclad Plus 2mm homogeneous continuous wall covering with flexible thermal welded joints is engineered with strength and flexibility to cope with differential substrate movement.

The new PU surface treatment resists dirt, stains and is designed to respond well to correct cleaning methods. The composition of the material is not conducive to bacterial growth.

Being 2mm homogeneous sheet material allows Polyclad to be overlapped or welded to the flooring material on the cove offering a watertight finish that will not crack or tear during differential movement when installed correctly.

When joining the wall sheet to the floor covering, Polyflor recommends the thermal welded method, which offers a stronger more secure join that will not separate from the floor covering during or after substrate movement leaving unseen imperfections where mould and microbes can breed.

Sustainable under foot safety is a critical factor in the selection of suitable floor covering for showers and wet areas. Polyflor offer a substantial range of sustainable slip resistant, resilient sheet products that have frictional qualities throughout the thickness of the material. This will sustain the original slip resistance for the warranted life of the product, provided the Manufacturers installation and maintenance recommendations are followed.

Installed correctly, Polysafe sustainable safety floor coverings offer water tight wet area solution that will satisfy the most discriminating designer whilst meeting the compliance requirements of AS/NZS 4586 wet pendulum and oil wet ramp tests.

An integral part of the wet room solution, is the selection and application of the correct floor and wall preparation screeds and adhesives. The advanced manufacturing technology used in the production of Kiesel products not only guarantees the integrity of the wet area installation for the warranted life of the products but the anti microbial OKMAS ingredient in Kiesel adhesives becomes another barrier against microbial development.

- **Polyflor Wet Room Products**
Sub Floor Preparation,
Floor/Wall Covering



■ Polyflor Wet Room Products

The following is a brief list of the products required for a complete Wet Room Solution. For specific technical advice, refer to the Technical Data section of this manual or contact the Polyflor field and technical services department on: 1800 777 425.

Sub Floor and Wall Preparation.

Kiesel Screeds and Adhesives

Floor and Wall substrate Priming Instructions

After the substrate surfaces have been prepared to a clean open porous substrate Polyflor Australia recommends Kiesel Okatmos® EG20 primer. This primer not only provides a mechanical key to the substrate for any required preparation but also acts as an anti-microbial that has unique technology that does not allow bacteria to grow.

Forming falls to waste outlets

If it is required to form falls to waste outlets we recommend Kiesel R300S which is a rapid curing cement based, very low emission fill and patching compound with high polymer content. It has no limitation as to how thick it is applied and can be mixed to a consistency that will be flowable or one that can be shaped. Kiesel R300S will cure at any thickness in approx 40 minutes. Alternatively Kiesel D800 is a self-levelling, self-drying compound that can be applied from 3mm to 40mm in one application. Clean dry sand can also be added up to 6kg per 20 kg bag so as it can be used for forming falls to drains and levelling up within the en-suites.

Preparing Walls for Installing Vinyl Sheet

Once the waterproofing has cured the walls will need to be prepared with a cementitious product to create the porosity required for water based adhesives to cure. So to alleviate this issue Polyflor recommend a generous coat of Kiesel F333, which is a cement-based patching and skim coating compound with very fine grain and high polymer content. Once it is dry enough to work over and smooth any edges it is then ready to receive adhesive and floor coverings.

Contact Adhesive on Waterproofing Membranes

Traditional solvent based, contact adhesives attack and destroy waterproofing membranes. We would recommend the use of Kiesel Okamul K5, which is a solvent-free acrylic contact adhesive for installation of coverings at walls and floors using the contact adhesion procedure.

Installation of the Vinyl Floor Sheet

To ensure optimum installation performance of the vinyl floor covering we recommend Kiesel Okamul PU, which is a solvent-free, very low emission, two-component, polyurethane resin adhesive. Okamul PU has superior bonding properties and is tough, hard as well as humidity and weather resistant after it has fully hardened. This adhesive is recommended for areas that will be subject to moisture ingress such as en-suites, kitchens and any other high stress installation area.

Installation of the Vinyl Wall Sheet

Once the walls have been prepared as described above Kiesel Okatmos® star 100 is a solvent free, anti-microbial, multi purpose adhesive that can be used for adhering the wall vinyl. It has an exceptional initial grab that makes it suitable for easy installation of the wall vinyl.

Wall Covering.

Polyclad Plus PU Wall Cladding

Thermal welded Polyclad Plus PU creates an impervious, continuous surface, which resists dirt and bacterial growth and will not shed dust.

This product is suitable for wall cladding in all wet and dry areas including, Medical, Aged Care, Pharmaceutical, laboratories, clean rooms, kitchens, canteens and other specialist areas.

- The wall cladding shall be Polyclad Plus PU, as manufactured by Polyflor Ltd. Of Manchester, England and distributed by Polyflor Australia Pty. Ltd.
- Flexible PVC sheeting in 2mm thickness
- Homogeneous and monolayer in construction
- The Manufacturer of the wall cladding is in possession of a valid quality systems certificate, showing compliance to ISO 9001:2000
- The Manufacturer is in possession of a valid environmental certificate showing compliance with ISO 14001.
- Reaction to Fire: The wall cladding is certified compliant to AS/NZS 3837 Group 1
- The product has been independently tested and demonstrates that it inhibits the growth of MRSA on walls

Floor Covering

Polysafe enhanced slip resistance sheet Vinyl

Thermal welded, coved Polysafe enhanced slip resistance floor covering offers a water tight finish that makes Polysafe products ideal for showers, wet areas, change rooms and any other areas that are subject to continuous water and liquid spills.

Ideal products are: Polysafe Hydro (bare foot only), Polysafe Standard, Polysafe Vogue Ultra, Polysafe Astral, and Polysafe Corona.

The floor shall be covered with Polysafe 2mm thick enhanced slip resistance sheet vinyl containing silicon carbide, colored quartz and aluminum oxide granules throughout its total thickness to impart sustainable slip resistant qualities.

Polysafe products comply fully with the following standards.	
EN649	General Manufacturing conformance
EN660	Abrasion Resistance Group T
EN 685	Use Area Classification 34 - Very heavy traffic commercial 43 - Heavy traffic light industrial
AS/NZS 4586	Slip Resistance Appendix D: Oil wet ramp test - R10 wet area rating Appendix A: Wet Pendulum Test - BPN of not less than 36
EN 13845	Resilient Floor Covering with particle based enhanced slip resistance qualities.
Surface Roughness R2:	Greater than 20 micron (HSE Protocol). Manufacturers must warrant that the initial slip resistant classification will be maintained as a minimum requirement for the guaranteed life of the product. Subject to the manufacturers published maintenance practices being followed.
AS/ISO 9239-1 –2003:	Fire Test – Conform to BCA specification C1 .10a
ISO 9001-2001:	The manufacturer is in possession of a valid quality system certificate
ISO 14001	The Manufacturer is in possession of a valid environmental certificate showing 1Showing compliance to ISO 14001.

SECTION 2

- **Installation of Wet Area System**
Sub Floor Preparation

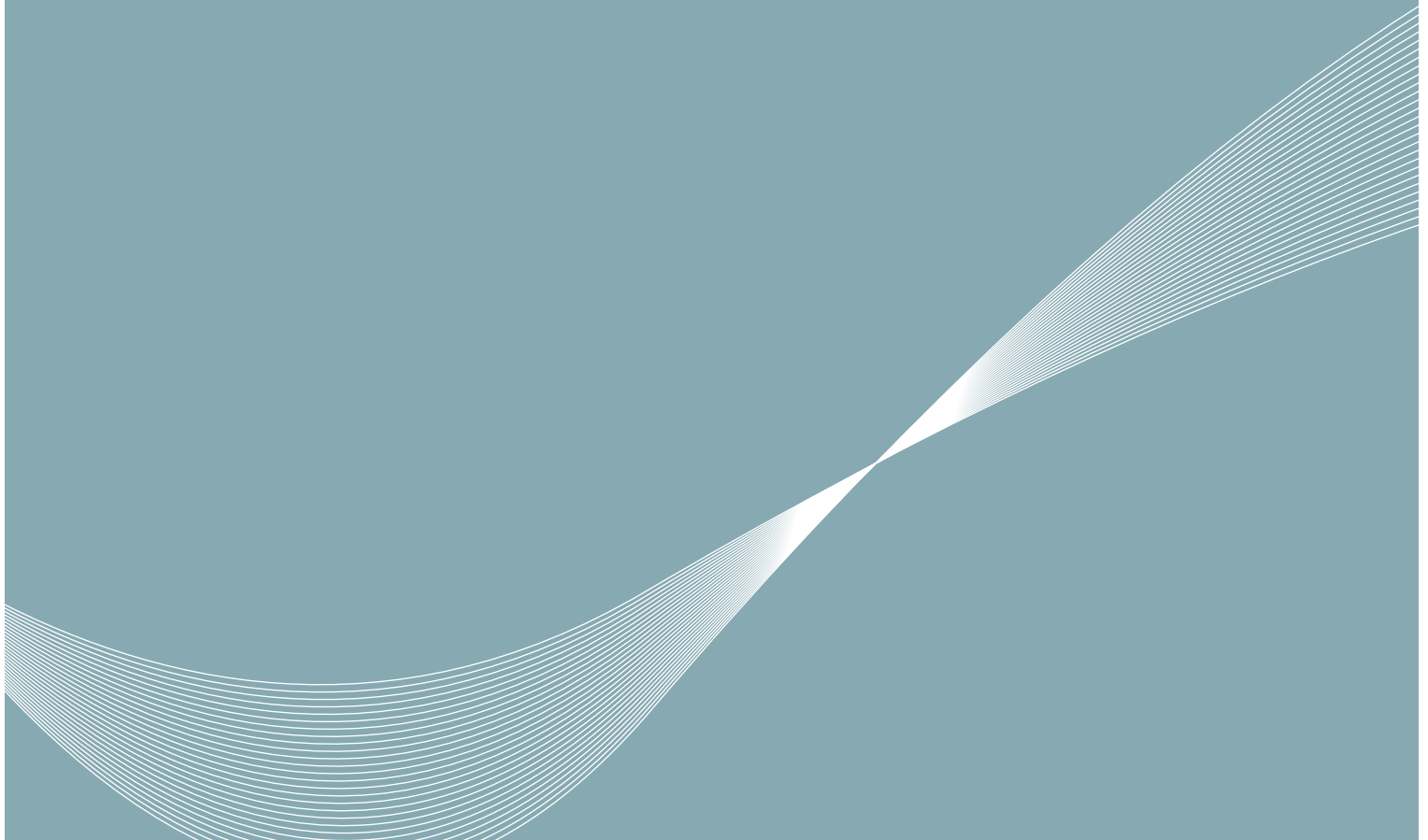

■ Installation

Polyflor Wet Area System

Introduction

This recommendation has been written to provide guidelines for the successful installation of Polyflor products to a "wet area" situation that have concrete substrates. A crucial part of any floor covering installation is its overall impact on the environment. Kiesel products all have EMICODE 'Very Low' EC1 rating that are all well below the acceptable level of allowed emissions. Kiesel primers and adhesives also have the unique advantage of being anti-microbial which does not allow bacteria to grow. Bacteria have been proven to be a major contributor of VOC's within an environment.

This system is designed for a total system that will perform beyond expectations but the successful installation is reliant on providing suitable site conditions and installing the products to this recommendation. Polyflor Australia is committed to providing the on site support and technical knowledge that will be required to ensure a successful warrantable installation of its products.

Substrate Preparation

Firstly the substrate needs to comply with Australian standard AS1884-1985 Floor coverings—Resilient sheet and tiles—Laying and maintenance practices in particular clause 2.1.1.3 Surface. (a) Plainness. When a straightedge 1.5 m long is placed on the surface at any position, no part of the surface shall be more than 6 mm below the straightedge. (b) Smoothness. When a straightedge 150 mm long is placed on the surface at any position, no part of the surface shall be more than 1 mm below the straightedge.

NOTE: Where a subfloor is so rough or uneven that it is unsuitable for the direct application of the floor covering, corrective action should be taken (e.g. steel-toweled underlay), as agreed between the purchaser and the floor laying contractor. Extra attention should be given to the wall substrate finish, as any imperfections in the smoothness or plainness of the surface will be magnified by side light reflection.

In recent times excessive surface contaminants such as "mark out paints" have been causing de-lamination and migration issues with vinyl installations. Every effort should be taken to ensure non-solvent based marks out paints are used. These types of contaminants including plaster, paint and general construction residues should

be mechanically removed from the surface via diamond grinding, shot blasting etc to ensure the surface is a clean open porous substrate. Following this the substrate should be thoroughly vacuumed to remove any dust, dirt and loose materials.

Note: We can not stress the importance enough for correct substrate preparation as this provides the key for the entire installation.

Floor and Wall substrate Priming Instructions

After the substrate surfaces have been prepared to a clean open porous substrate Polyflor Australia recommends Kiesel Okatmos® EG20 primer. This primer not only provides a mechanical key to the substrate for any required preparation but also acts as an anti-microbial that has unique technology that does not allow bacteria to grow. Kiesel Okatmos® EG20 is to be diluted at a ratio of 1:3 (1 parts primer to 3 parts water) this is then to be applied to the substrate using a soft broom or short nap roller ensuring no puddles or pooling of the primer. A thin even coat should be applied to the surface ensuring any pooling or puddles are broomed or rolled out. Puddling or pooling will cause extended dry time and a rubbery surface that could cause a weak bond between the substrate and the leveling compound. This should then be allowed to cure for a minimum 30 minutes or until dry and not tacky. Do not begin the installation of Kiesel products before the primer has completely dried.

Note: It is crucial when installing any of the Kiesel range of products that an environment is created to the conditions as stated in AS 1884 and AS/NZ 2455 2007 i.e. provide fans or blowers at a minimum to create airflow for the removal of the dense still air. This along with providing the optimum operating temperatures will help to ensure optimum performance of these products.

Forming falls to waste outlets

If it is required to form falls to waste outlets we recommend Kiesel R300S which is a rapid curing cement based, very low emission fill and patching compound with high polymer content. It has no limitation as to how thick it is applied and can be mixed to a consistency that will be flowable or one that can be shaped. Kiesel R300S will cure at any thickness in approx 40 minutes.

Alternatively Kiesel D800 is a self-levelling, self-drying compound that can be applied from 3mm to 40mm in one application. Clean dry sand can also be added up to 6kg per 20 kg bag so as it can be used for forming falls to drains and levelling up within the en-suites.

Waterproofing of Floors and Walls

Preparing Walls for Installing Vinyl Sheet

Once the waterproofing has cured the walls will need to be prepared with a cementitious product to create the porosity required for water based adhesives to cure. So to alleviate this issue I recommend that a generous coat of Kiesel F333 which is a cement-based patching and skim coating compound with very fine grain and high polymer content. Once it is dry enough to work over and smooth any edges it is then ready to receive adhesive and floor coverings.

Contact Adhesive on Waterproofing Membranes

Traditional solvent based contact adhesives attack and destroys the waterproofing membranes. We would recommend the use of Kiesel Okamul K5, which is a solvent-free acrylic contact adhesive for installation of coverings at walls and floors using the contact adhesion procedure. This would be the perfect substitution for a solvent-based contact. It is applied in the same manner but has an extended initial tack time of 30 minutes. Once tack is achieved it works extremely well for the coving or high stress parts of the installation like internal and external corners. Once cured it is impermeable to water.

- **Installation of Floor Covering**
Polysafe Vinyl Floor Sheet



■ Installation of Polysafe Vinyl Floor Sheet

To ensure optimum installation performance of the vinyl floor covering we recommend Kiesel Okamul PU, which is a solvent-free, very low emission, two-component, polyurethane resin adhesive. Okamul PU has superior bonding properties and is tough, hard as well as humidity and weather resistant after it has fully hardened. This adhesive is recommended for areas that will be subject to moisture ingress such as en-suites, kitchens and any other high stress installation area.

The two components are added together and mixed thoroughly; it is then applied to the substrate using a U1 notch trowel or an A3 notch trowel. The floor covering is applied into the wet adhesive and followed by being rolled with a 45kg roller to ensure transfer of the adhesive to the back of the floor covering. The adhesive will set in approximately 30 minutes.

When installing Polysafe sheet safety floor coverings refer to the instructions; Installation of Homogeneous & Safety Vinyl Sheet (See Section 7, Page 25), available from any Polyflor Office or the website; [HYPERLINK "http://www.polyflor.com"](http://www.polyflor.com) under the technical section.

For wet areas such as showers and bathrooms particular attention must be given to Thermal Welding (see Welding Vinyl Flooring instructions). It is important that the joints to be welded are correctly grooved and welded to ensure a watertight finish.

Where ever possible joins should be avoided in the shower floor area. Should a join be necessary it is best to plan the join as far away from the running water as possible.

Showers and areas subjected to running water should be coved up the wall at least 150mm. In order to achieve a consistent and correct radius, PVC cove former should be fitted to the floor/wall junction around the perimeter of the installation before the floor covering is installed (see Fig's 1 and 2)

Important: When coving (Min150mm) the internal corner must be cut 10mm from the base of the shower and at 45 degrees to the corner (see Fig 3). Never weld directly into the corner as this becomes a weak point during sub strait movement which can lead to a breach of the water tight finish. It is also more difficult to achieve a strong and tidy weld.

External corners should be treated in the same way as internal corners (see Fig3) However where there is a single external corner it is acceptable to cut both sides on the wrap of the cove at 45 degrees and cut a separate infill to wrap around the corner. This is known as a butterfly join.

It is recommended that a SPS type floor Drain be fitted when installing Polysafe sheet vinyl floor covering in showers and areas that are subjected to running water (See Fig 5).

There are various sizes available including one that is fitted with an " O "ring designed to be pushed inside the drain pipe.

SPS type floor drains are designed to allow the floor covering to be fitted into the drain and be held in place with a fitted flange allowing a waterproof connection to the drain.

■ Installation of Vinyl Wall Sheet Polyclad Plus Vinyl Wall Sheet

Overlap/Welded Methods



■ Installation of the Vinyl Wall Sheet

Introduction

Once the walls have been prepared as previously described Kiesel Okatmos® star 100 is a solvent free, anti-microbial, multi purpose adhesive that can be used for adhering the wall vinyl. It has an exceptional initial grab that makes it suitable for easy installation of the wall vinyl. Okatmos® star 100 can be applied using a V1 notch trowel or an A3 notch trowel. Once the adhesive has initial tack after approximately 5-15 minutes depending on site conditions the floor covering can be installed into the adhesive. This is then to be rolled with a 45kg roller to ensure transfer of the adhesive to the back of the wall covering. In the case of wall vinyl a hand roller is to be used using pressure to ensure transfer. Final cure will be in 24 hours.

Fitting wall cladding to showers and wet areas requires some planning to minimise joins in areas subjected to running water. It is better to avoid welded wall joins in a shower cubicle if possible. Where that option is not possible the welded join should not be closer than 200mm to the internal corner (see Fig 3)

Overlap method. (Fig 1)

Cut the lengths slightly longer (approx 75mm) than the measurement from the top of the floor cove to the ceiling or pre marked required height of the wall cladding.

Fix a reducing strip to the top of the cove using Okamul K5 (Fig 1)

Install the first sheet in the corner of the shower. Measure the width of the sheet finding the centre and mark with a pencil. Apply Okamul K5 in a 200mm band down the centre line of the cladding and in the same position on the internal corner.

Apply a min 100mm of Okamul K5 across the top of the sheet and on the corresponding wall and allow tacking off as per previous instructions (Contact Adhesives).

(The same method can be used on external corners using a hand roller).

Make an accurate vertical chalk line on the wall, 1m from the corner, the full length of the drop. This will give a straight edge for the next sheet.

Apply Okamul Star 100 as per previous instructions and fit the first drop pushing the material firmly into the corner using a corner roller, making sure that the sheet overlaps the cove by at least 50mm.

Press the material into the adhesive using a board with a rounded edge working from the top and from the centre to the edge of the drop. Clean up excess adhesive.

Fit the next drop using the same method and fit leaving .5 to 1mm gap between the sheets. Clean up excess adhesive. Continue this process until the wall cladding is complete.

Apply Okamul Star 100 to the face of the cove down a minimum of 30mm and roll the wall cladding into the adhesive. Use a heat gun to assist with the overlap.

Using a straight edge, trim the overlap to the desired length leaving a minimum of 30mm overlap. (Fig 1)

Note: All joins should be grooved (using a grooving tool) to a depth 2/3 the thickness of the material.

Joins should not be welded on the same day of installation.

Welds should not be trimmed until the weld is cool.

Welded Method. (Fig 2)

Polyflor recommends this method as it offers a complete watertight solution that is strong and flexible when subjected to differential movement.

Should a breach occur during the life of the installation, the weld can be easily replaced.

The Welded method follows the same installation procedure as the overlap method with the exception of the overlap.

A reducing strip is not required as the 2mm wall cladding is simply finished at the top of the cove of the 2mm floor vinyl leaving a gap of .5 to 1mm to allow for grooving and welding (see Fig 2).

This recommendation has been written to ensure the best possible performance for all products listed above, to be installed in a wet room or wet area project.

Using these guidelines will ensure a total system warranty from the substrate to the Polyflor floor and wall coverings. Polyflor Australia will warrant the entire system for a period up to 15 years.

■ **Installation Drawings**
Figures 1, 2, 3, 4 & 5

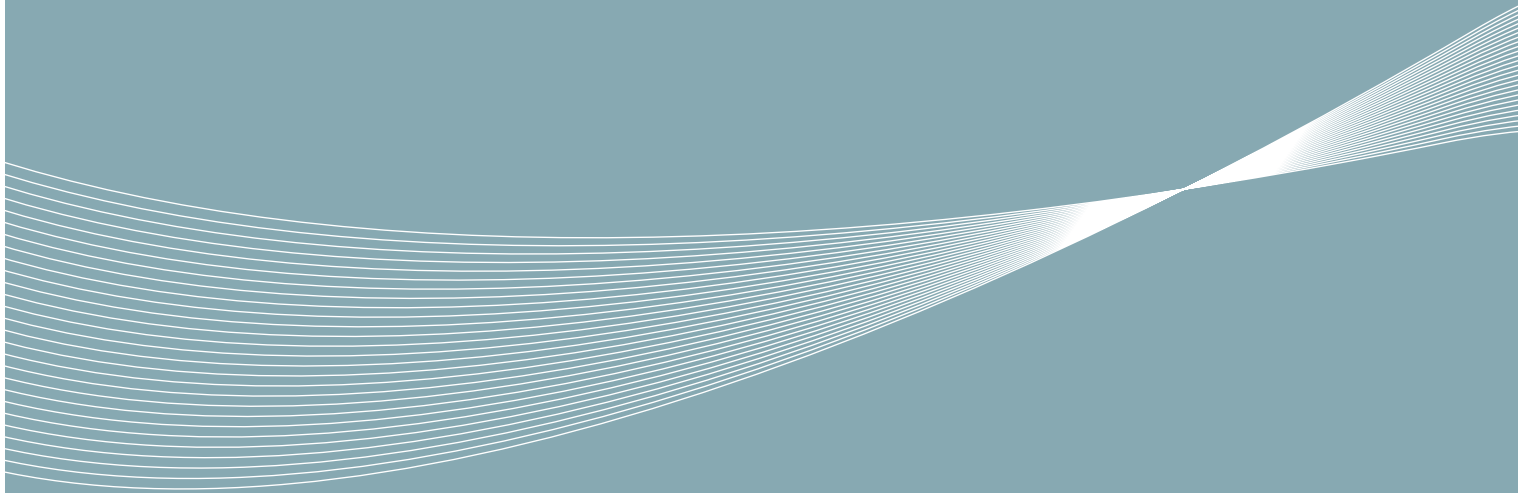

■ Figure 1

Overlap Method

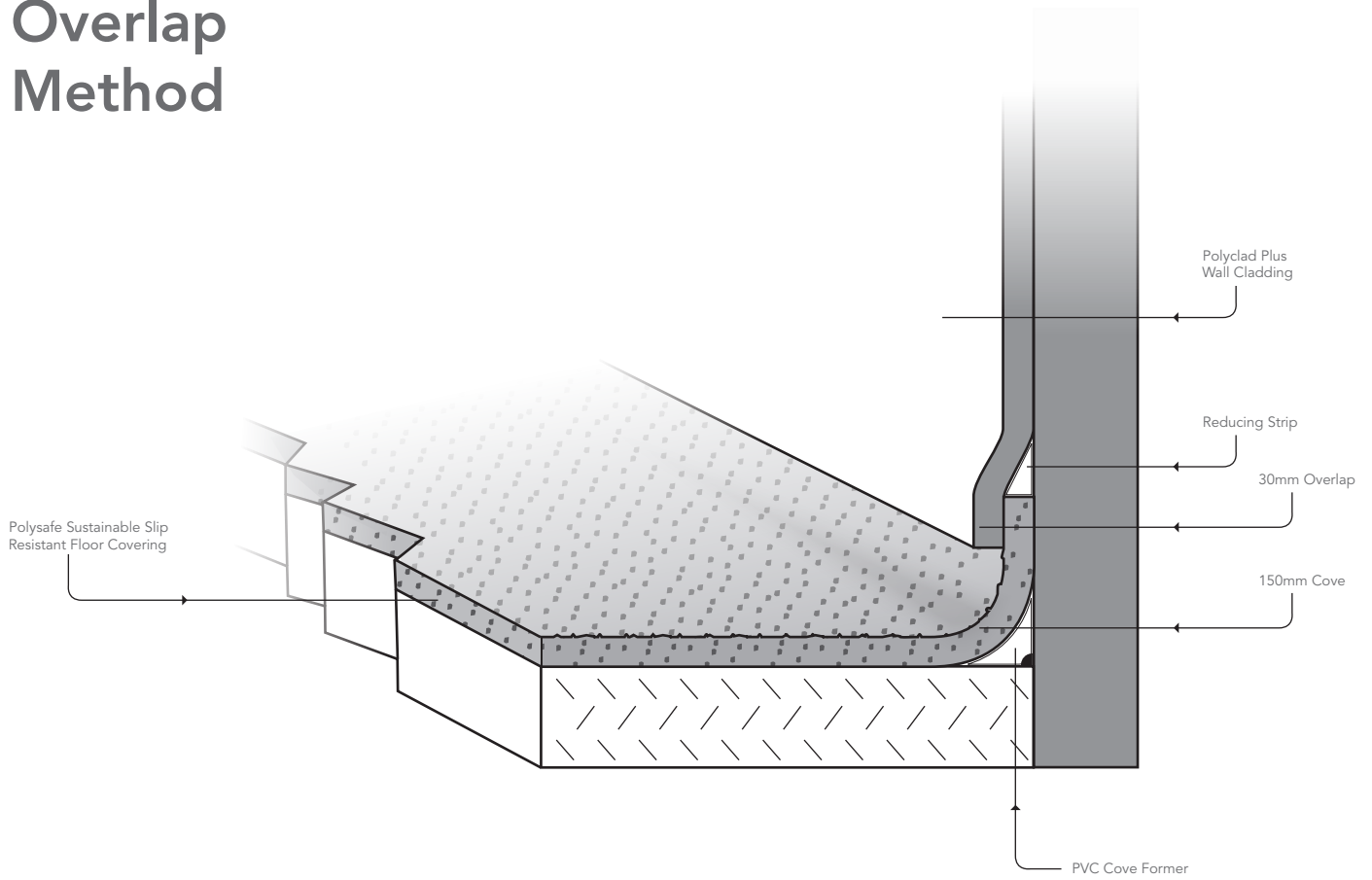

■ Figure 2

Thermal Welded Method

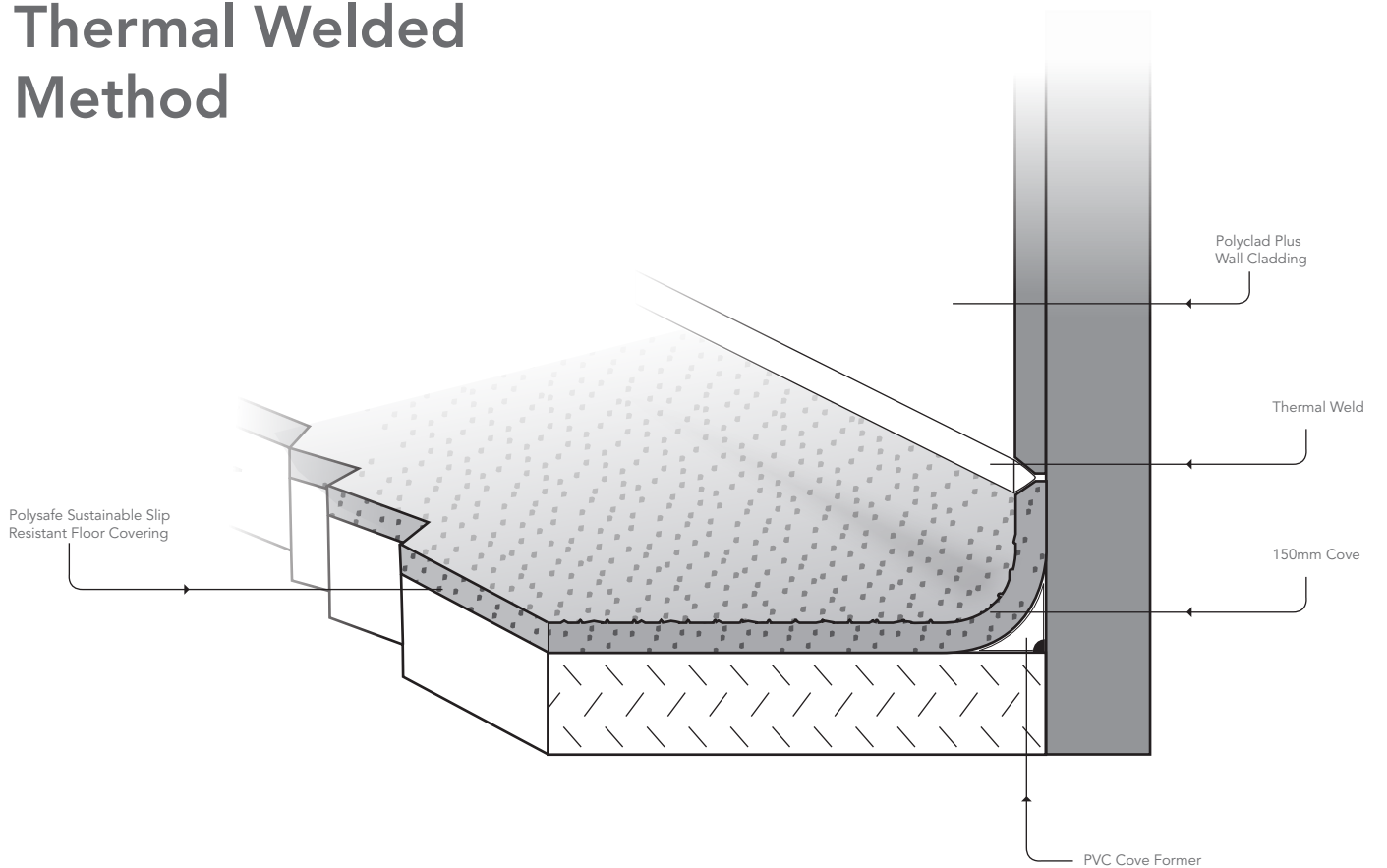

■ Figure 3

Thermal Welded Method (Internal & External Corners)

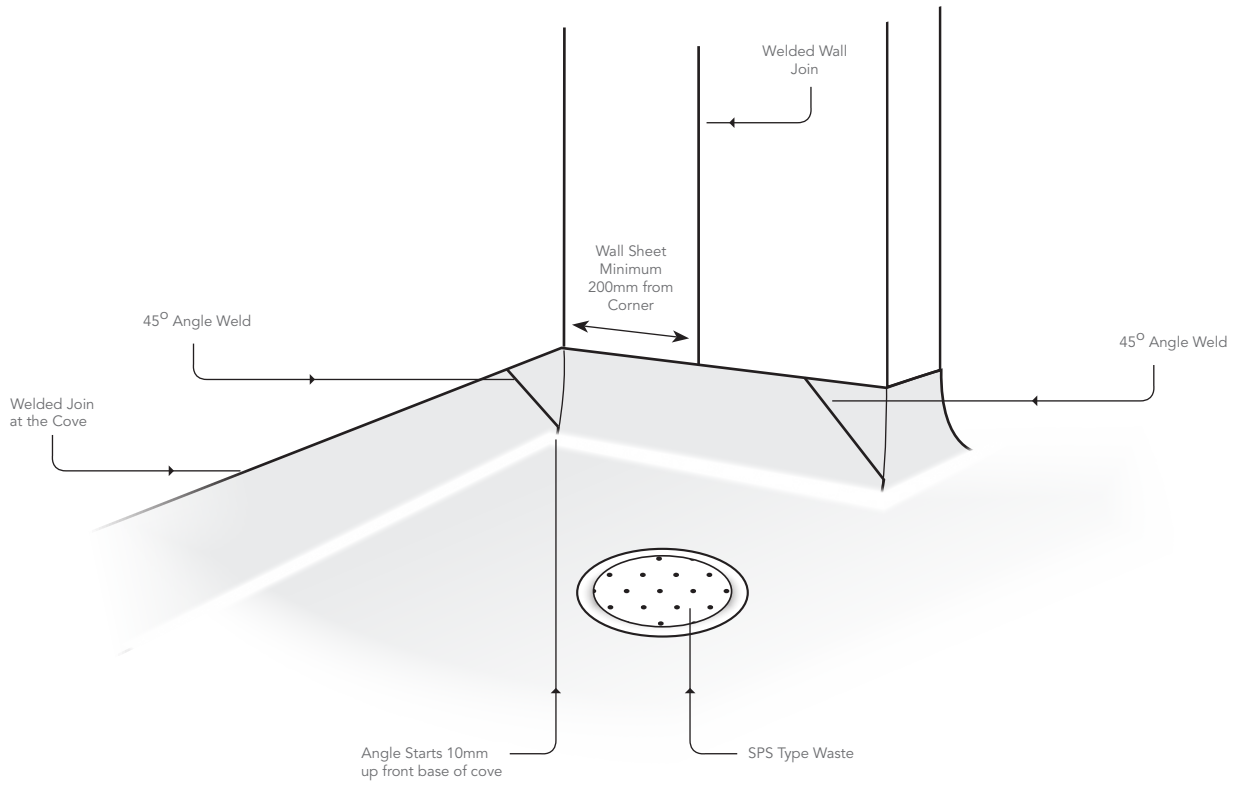

■ Figure 4

Fitting to Ceramic Wall Tiles

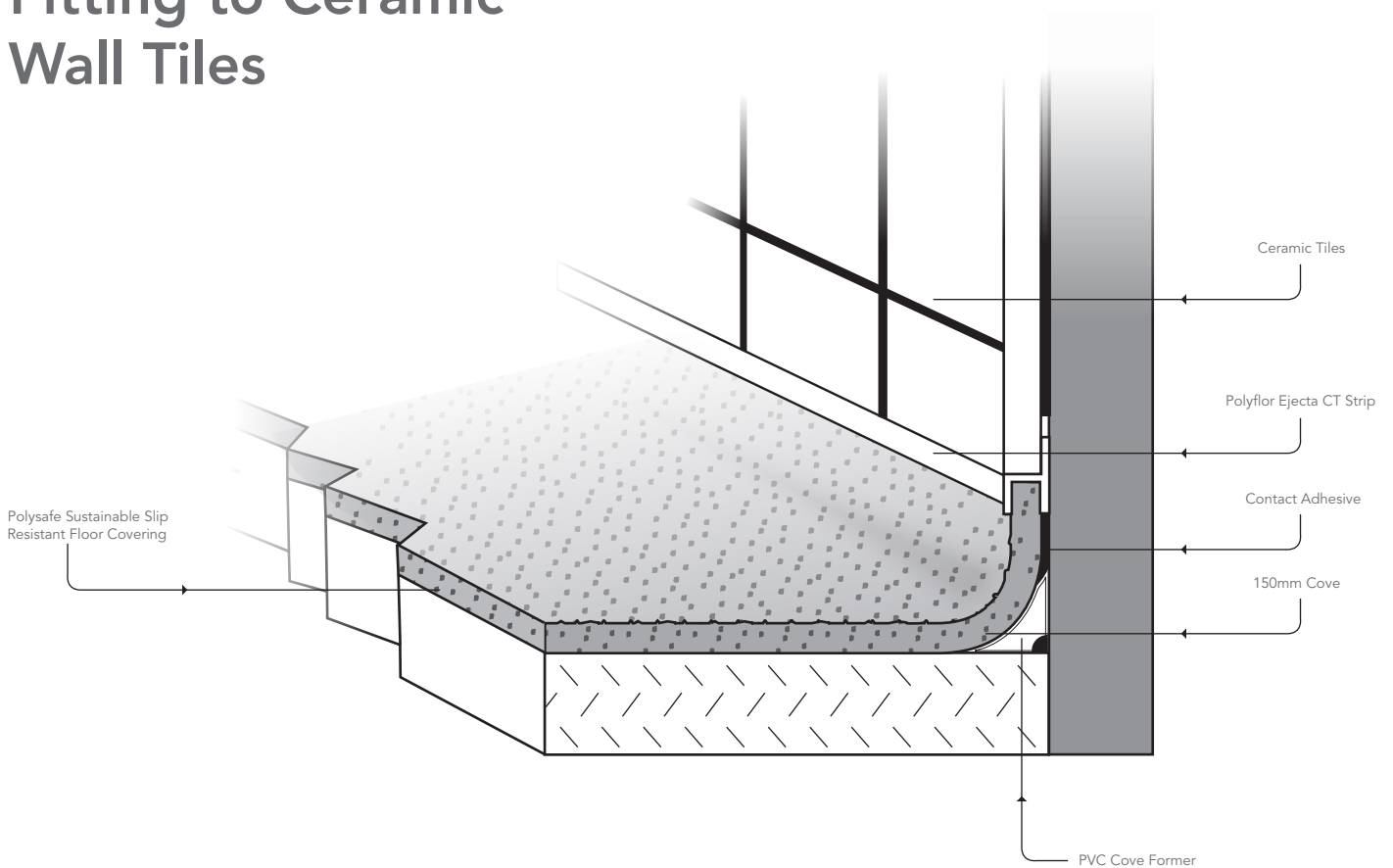

■ Figure 5

SPS 100m Push-in Sheet Vinyl Floor Waste (New Compact Top Model)

Specification codes:

- V100CPA (Bronze body, chrome-plated ring & grate)
- V100SBA (Brass body, polished 304 SS ring & grate)
- V100SSA (Assembly in polished 316 stainless steel)

- Push-in floor waste assembly for sheet vinyl flooring.
- Vinyl floor drain body available in brass, bronze or 316 stainless steel.
- Ring & grate available in chrome-plated bronze or polished 304 and 316 stainless steel.
- O-rings adapt spigot to 100mm PVC, copper, HDPE and CI pipe.

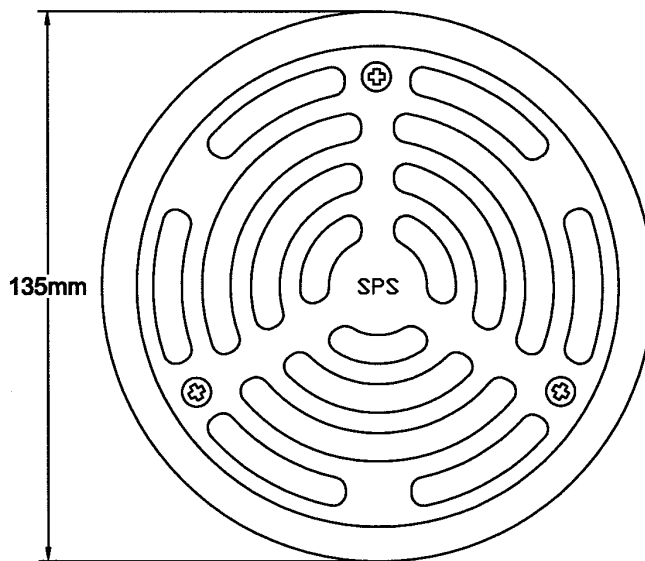

Polysafe Sustainable
Slip Floorcovering

Typical Application

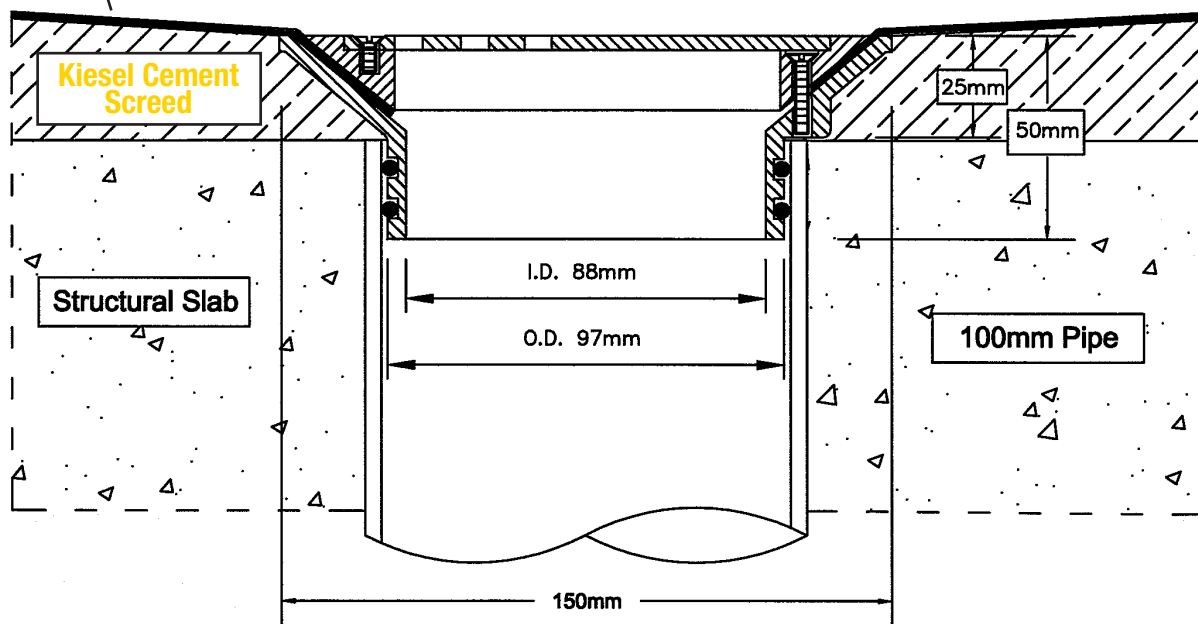

■ Figure 5

SPS 100m Push-in Sheet Vinyl Floor Waste (New Compact Top Model)

Specification code:
V100SVA (Polished 304 SS ring & grate, PVC body)

- Push-in floor waste assembly for sheet vinyl flooring.
- Vinyl floor drain body made from PVC plastic.
- Ring & grate made from polished 304 stainless steel.
- O-rings adapt spigot to 100mm PVC, copper, HDPE and CI pipe.

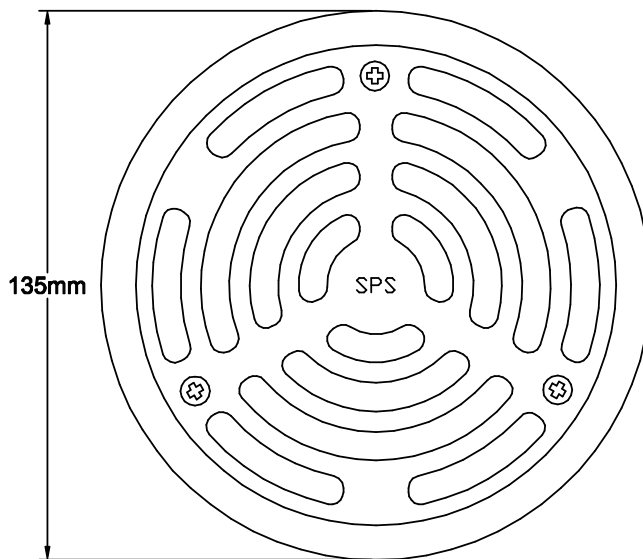

Polysafe Sustainable Slip Floorcovering

Typical Application

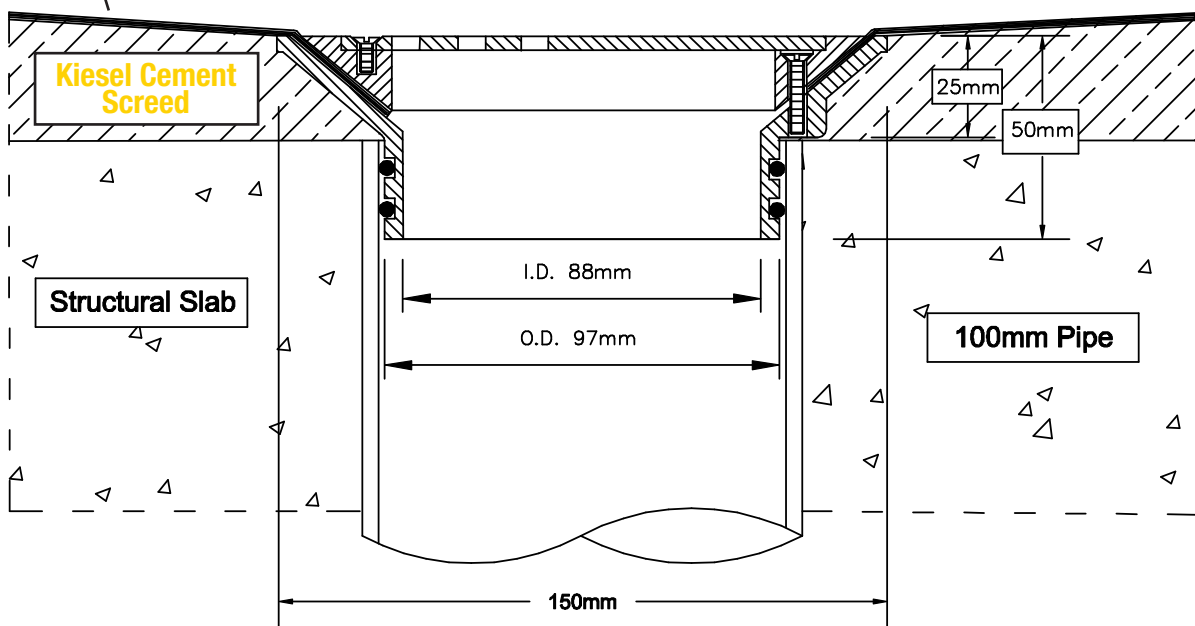

SECTION 6

■ Technical Support Data

Performance Specifications

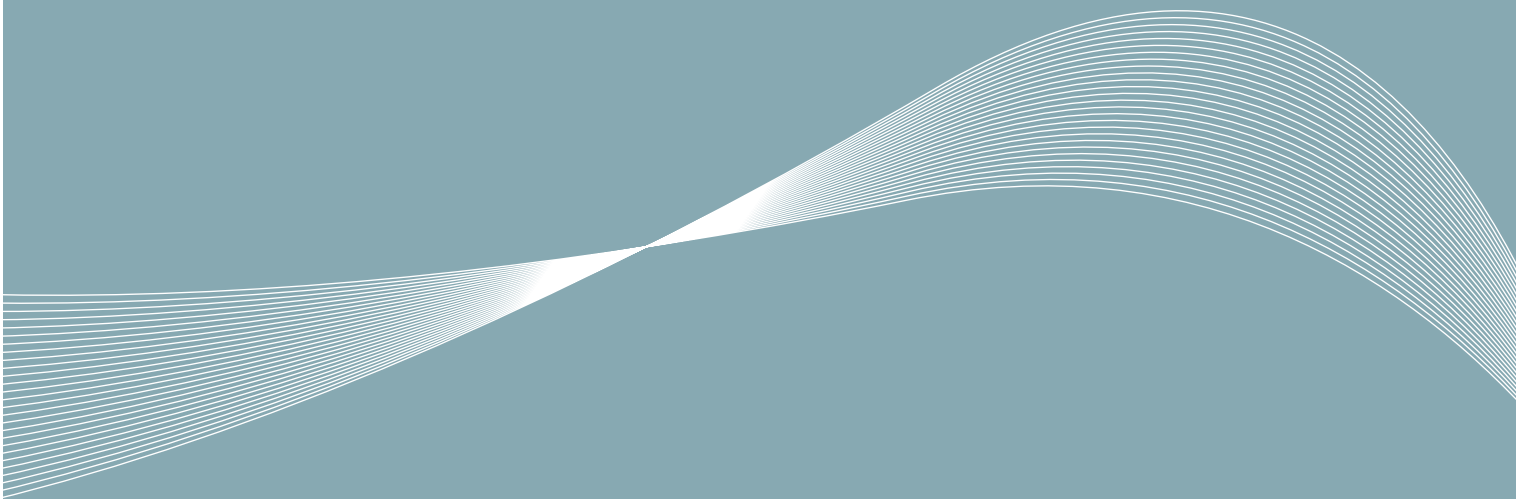

POLYSAFE STANDARD

- A range of 16 colours available with a traditional decoration
- Coloured quartz, aluminium oxide and silicon carbide particles incorporated throughout the full thickness of the vinyl to improve traction and safety underfoot

SPECIFICATION



2.0mm
2.5mm



2m x 20m = 40m²
2m x 20m = 40m²



2430g/m²
3100g/m²



GENERAL PERFORMANCE

EN 13845
ASTM F1303
Agrément – G5ws



REACTION TO FIRE

EN 13501-1 Class Bfl-S1
EN ISO 9239-1 ≥8kw/m²
EN ISO 11925-2 Pass
ASTM E648 Class 1



ENHANCED SLIP

Sustainable wet slip resistance* AS/NZS 4586 R10
EN 13845 ESf

RRL Pendulum Test ≥36 (wet test - 4S Rubber/Slider 96)
Surface roughness Rz ≥20µm

The slip resistance across all Polysafe products is assured throughout the guaranteed life of the product, with strict adherence to HSE Guidelines.



ABRASION RESISTANCE
EN 13845 50,000 cycles
EN 649 Group T



VOC EMISSIONS
AgBB VOC test : Pass
(Low Result)



RESISTANCE TO CHEMICALS

Polysafe Standard has good resistance to dilute acids and alkalis. The Polyflor Technical Information Manual provides a general guide. Chemical resistance charts by shade are available on request.



HYGIENE

Contains antimicrobial agents for improved hygiene protection.
This product has been independently tested and results demonstrate that it inhibits the growth of MRSA. An effective cleaning regime is however, the most important defence against infection.



ELECTRICAL BEHAVIOUR (body voltage)

EN 1815 This product does not accumulate static charges above 2kV and is classified as 'antistatic'. For specialist applications where there is a requirement to dissipate the electrostatic charge, see the Polyflor ESD product ranges.



APPLICATIONS

Polysafe Standard is ideal for use in areas where contaminant spillages can occur, making slip resistance an important consideration. Typical areas include clinics, laundry and sluice rooms, nursing homes, washrooms, WCs, bar servery, food preparation areas, kitchens, canteens and institutional applications. For continually wet areas please refer to our Polysafe Hydro range. As with all Polysafe products, Polysafe Standard should not have a polish applied.



For information regarding handling and installation, adhesives, maintenance, applications and chemical resistance, consult Polyflor Customer Technical Services on +44 (0)161 767 1912, or email tech@polyflor.com.

At the date of issue the data presented is correct.

However, Polyflor Ltd. reserves the right to make changes which do not adversely affect performance or quality.

* For clarification regarding slip resistance, consult Polyflor.



POLYFLOR LTD. PO BOX 3 RADCLIFFE NEW ROAD WHITEFIELD MANCHESTER M45 7NR UK
TEL: +44 (0)161 767 1111 UK SALES DIRECT: +44 (0)161 767 1122 UK FAX: +44 (0)161 767 1128
EXPORT FAX: +44 (0)161 767 1166 E-MAIL: INFO@POLYFLOR.COM WWW.POLYFLOR.COM
UK SAMPLE REQUESTS: +44 (0)161 767 2551

James Halstead
FLOORING



POLYFLOR
**POLYSAFE™
STANDARD**

SAFETY FLOORING

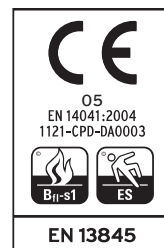
PERFORMANCE AND
PROPERTIES

POLYSAFE VOGUE ULTRA

- A range of 12 decorative colours with co-ordinating chip and special surface finish
- Coloured quartz, aluminium oxide and silicon carbide particles incorporated throughout the full thickness of the vinyl to improve traction and safety underfoot

SPECIFICATION



2.0mm

2m x 20m = 40m²2400g/m²

GENERAL PERFORMANCE

EN 13845
ASTM F1303
Agrément – G5ws



REACTION TO FIRE

EN 13501-1 Class Bfl-S1 { EN ISO 9239-1 ≥8kw/m²
EN ISO 11925-2 Pass
ASTM E648 Class 1



ENHANCED SLIP

Sustainable wet slip resistance* AS/NZS 4586 R10
EN 13845 ESf
RRL Pendulum Test ≥36 (wet test - 4S Rubber/Slider 96)
Surface roughness Rz ≥20µm

The slip resistance across all Polysafe products is assured throughout the guaranteed life of the product, with strict adherence to HSE Guidelines.



ABRASION RESISTANCE
EN 13845 50,000 cycles
EN 649 Group T



VOC EMISSIONS
AgBB VOC test : Pass
(Low Result)



RESISTANCE TO CHEMICALS

Polysafe Vogue Ultra has good resistance to dilute acids and alkalis. The Polyflor Technical Information Manual provides a general guide. Chemical resistance charts by shade are available on request.



HYGIENE

Contains antimicrobial agents for improved hygiene protection. This product has been independently tested and results demonstrate that it inhibits the growth of MRSA. An effective cleaning regime is however, the most important defence against infection.



ELECTRICAL BEHAVIOUR (body voltage)

EN 1815 This product does not accumulate static charges above 2kV and is classified as 'antistatic'. For specialist applications where there is a requirement to dissipate the electrostatic charge, see the Polyflor ESD product ranges.



APPLICATIONS

Polysafe Vogue Ultra is designed for use in areas where enhanced slip resistance is an important consideration. Typical areas include washrooms, WCs, bar serveries, food preparation areas, changing rooms, laundry and sluice rooms, canteens and institutional applications. For continually wet areas please refer to our Polysafe Hydro range. As with all Polysafe products, Polysafe Vogue Ultra should not have a polish applied.



For information regarding handling and installation, adhesives, maintenance, applications and chemical resistance, consult Polyflor Customer Technical Services on +44 (0)161 767 1912, or email tech@polyflor.com. At the date of issue the data presented is correct. However, Polyflor Ltd. reserves the right to make changes which do not adversely affect performance or quality.

* For clarification regarding slip resistance, consult Polyflor.



POLYFLOR LTD. PO BOX 3 RADCLIFFE NEW ROAD WHITEFIELD MANCHESTER M45 7NR UK
TEL: +44 (0)161 767 1111 UK SALES DIRECT: +44 (0)161 767 1122 UK FAX: +44 (0)161 767 1128
EXPORT FAX: +44 (0)161 767 1166 E-MAIL: INFO@POLYFLOR.COM WWW.POLYFLOR.COM
UK SAMPLE REQUESTS: +44 (0)161 767 2511

James Halcroft
FLOORING



2006

2007

POLYFLOR
POLYSAFE™
VOGUE ULTRA

SAFETY FLOORING

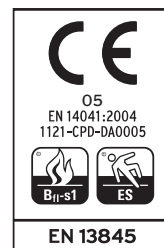
PERFORMANCE AND
PROPERTIES

POLYSAFE HYDRO

- Raised emboss safety flooring, suitable for barefoot and continually wet areas
- Conforms fully with EN 13845 Barefoot
- Coloured quartz, aluminium oxide and silicon carbide particles incorporated throughout the full thickness of the vinyl to improve traction and safety underfoot

SPECIFICATION



2.0mm

2m x 20m = 40m²2450g/m²

GENERAL PERFORMANCE

EN 13845
ASTM F1303

Agrément – G5ws



REACTION TO FIRE

EN 13501-1 Class Bfl-S1 { EN ISO 9239-1 ≥8kw/m²
EN ISO 11925-2 Pass

ASTM E648 Class 1



ENHANCED SLIP

Sustainable wet slip resistance*

AS/NZS 4586 Part C Class B

EN 13845 ESb

RRL Pendulum Test ≥36 (wet test - 4S & TRL Rubber)

Surface roughness Rz ≥20µm

The slip resistance across all Polysafe products is assured throughout the guaranteed life of the product, with strict adherence to HSE Guidelines.



ABRASION RESISTANCE

EN 649 Group P



VOC EMISSIONS

AgBB VOC test : Pass
(Low Result)

WATER TIGHTNESS

EN 13553 Annex A



RESISTANCE TO CHEMICALS

Polysafe Hydro has good resistance to dilute acids and alkalis. The Polyflor Technical Information Manual provides a general guide. Chemical resistance charts by shade are available on request.



HYGIENE

Contains antimicrobial agents for improved hygiene protection.

This product has been independently tested and results demonstrate that it inhibits the growth of MRSA. An effective cleaning regime is however, the most important defence against infection.



ELECTRICAL BEHAVIOUR (body voltage)

EN 1815 This product does not accumulate static charges above 2kV and is classified as 'antistatic'. For specialist applications where there is a requirement to dissipate the electrostatic charge, see the Polyflor ESD product ranges.



APPLICATIONS

Polysafe Hydro is specially designed with a raised profile emboss, giving greater confidence in specifying for areas that are subjected to constant running water and where enhanced slip resistance is a prime consideration. Suitable for areas where barefoot or soft soled footwear is worn - examples include walk-in showers, hydrotherapy areas and barefoot recreational areas such as changing room facilities and indoor swimming pool surrounds. As with all Polysafe products, Polysafe Hydro should not have a polish applied.



For information regarding handling and installation, adhesives, maintenance, applications and chemical resistance, consult Polyflor Customer Technical Services on +44 (0)161 767 1912, or email tech@polyflor.com.

At the date of issue the data presented is correct.

However, Polyflor Ltd. reserves the right to make changes which do not adversely affect performance or quality.

* For clarification regarding slip resistance, consult Polyflor.



POLYFLOR LTD. PO BOX 3 RADCLIFFE NEW ROAD WHITEFIELD MANCHESTER M45 7NR UK
 TEL: +44 (0)161 767 1111 UK SALES DIRECT: +44 (0)161 767 1122 UK FAX: +44 (0)161 767 1128
 EXPORT FAX: +44 (0)161 767 1166 E-MAIL: INFO@POLYFLOR.COM WWW.POLYFLOR.COM
 UK SAMPLE REQUESTS: +44 (0)161 767 2551

James Halstead
 FLOORING



2006

2007

POLYFLOR
POLYSAFE™
HYDRO

SAFETY FLOORING

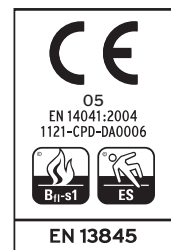
PERFORMANCE AND
PROPERTIES

POLYSAFE CORONA

- A range of 12 decorative colours with co-ordinating chip and special surface finish, incorporating low maintenance Supratec⁺
- Coloured quartz, aluminium oxide and silicon carbide particles incorporated throughout the full thickness of the vinyl to improve traction and safety underfoot

SPECIFICATION



2.0mm



2m x 20m = 40m²



2400g/m²



GENERAL PERFORMANCE

EN 13845
ASTM F1303
Agrément – G5ws



REACTION TO FIRE

EN 13501-1 Class Bfl-S1
ASTM E648 Class 1
EN ISO 9239-1 ≥8kw/m²
EN ISO 11925-2 Pass



ENHANCED SLIP

Sustainable wet slip resistance* AS/NZS 4586 R10
EN 13845 ESf
RRL Pendulum Test ≥36 (wet test - 4S Rubber/Slider 96)
Surface roughness Rz ≥20µm
The slip resistance across all Polysafe products is assured throughout the guaranteed life of the product, with strict adherence to HSE Guidelines.



ABRASION RESISTANCE

EN 13845 50,000 cycles
EN 649 Group T



VOC EMISSIONS

AgBB VOC test : Pass
(Low Result)



RESISTANCE TO CHEMICALS

Polysafe Corona has good resistance to dilute acids and alkalis. The Polyflor Technical Information Manual provides a general guide. Chemical resistance charts by shade are available on request.



HYGIENE

Contains antimicrobial agents for improved hygiene protection. This product has been independently tested and results demonstrate that it inhibits the growth of MRSA. An effective cleaning regime is however, the most important defence against infection.



Polysafe Corona with Supratec⁺, enhanced with Polyurethane for even greater maintenance benefits. As with all Polysafe products, Polysafe Corona should not have a polish applied.



ELECTRICAL BEHAVIOUR (body voltage)

EN 1815 This product does not accumulate static charges above 2kV and is classified as 'antistatic'. For specialist applications where there is a requirement to dissipate the electrostatic charge, see the Polyflor ESD product ranges.



APPLICATIONS

Polysafe Corona is ideal for use in areas where enhanced slip resistance is required. Supratec⁺ provides greater confidence in specifying for areas that are subject to contaminant spillages and are hygiene critical locations e.g. food preparation areas, kitchens and bar serveries. The advantages in cleanability make Polysafe Corona suitable for general areas e.g. supermarkets, clinics, laundry and sluice rooms, nursing homes, washrooms, WCs, schools and universities, laboratories and many institutional applications. For continually wet areas please refer to our Polysafe Hydro range.



For information regarding handling and installation, adhesives, maintenance, applications and chemical resistance, consult Polyflor Customer Technical Services on +44 (0)161 767 1912, or email tech@polyflor.com. At the date of issue the data presented is correct. However, Polyflor Ltd. reserves the right to make changes which do not adversely affect performance or quality. * For clarification regarding slip resistance, consult Polyflor.



POLYFLOR LTD. PO BOX 3 RADCLIFFE NEW ROAD WHITEFIELD MANCHESTER M45 7NR UK
TEL: +44 (0)161 767 1111 UK SALES DIRECT: +44 (0)161 767 1122 UK FAX: +44 (0)161 767 1128
EXPORT FAX: +44 (0)161 767 1166 E-MAIL: INFO@POLYFLOR.COM WWW.POLYFLOR.COM
UK SAMPLE REQUESTS: +44 (0)161 767 2551

James Halstead
FLOORING



POLYFLOR
**POLYSAFE™
CORONA**

WITH NEW



SAFETY FLOORING

PERFORMANCE AND
PROPERTIES

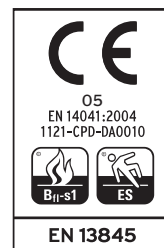

POLYFLOR™
COVERING THE WORLD

POLYCLAD PLUS PU

- Tough, durable and low maintenance PVC wall and ceiling cladding, with subtle marbleisation
- Polyurethane surface treatment

SPECIFICATION



TOTAL THICKNESS
EN 428 2.0mm



ROLL SIZE
EN 426 2m x 20m = 40m²



TOTAL WEIGHT
EN 430 Group 1: 3530g/m²



REACTION TO FIRE
BS 476: Part 6 (I) <12 (i) <6 } meets UK class O*
BS 476: Part 7 Class 1
ASTM E648 Class 1
AS/NZS 3837 Group 1

*These results are achieved using Laybond 77 and a plasterboard. This combination of Polyclad Plus PU, adhesive and substrate meets the Class O requirement of Part B of the UK Building Regulations.



CLEAN ROOMS
ASTM F51/68 Class A - 'non-shedding'.
Suitable for use in the following classes of clean room:
ISO 14644-1 1999 Class 4



HYGIENE
This product has been independently tested and results demonstrate that it inhibits the growth of MRSA on the wall cladding. An effective cleaning regime is however, the most important defence against infection.



LIGHT FASTNESS
ISO 105-B02 Method 3 ≥6



APPLICATIONS
Welded Polyclad Plus PU creates an impervious, continuous surface which offers no sanctuary to dirt and bacteria and will not shed dust. Developed specifically to meet the advanced requirements of today's medical, science and electronics industries. Polyclad Plus PU has applications in cleanrooms, semi-conductor manufacture, the pharmaceuticals industry, food processing plants, kitchens and any area where hygiene, low maintenance and economy are important. It is recommended that Polyclad Plus PU is used in conjunction with the Polyflor range of vinyl floorcoverings.



For information regarding handling and installation, adhesives, maintenance, applications and chemical resistance, consult Polyflor Customer Technical Services on +44 (0)161 767 1912, or email tech@polyflor.com.
At the date of issue the data presented is correct.
However, Polyflor Ltd. reserve the right to make changes which do not adversely affect performance or quality.



POLYFLOR LTD. PO BOX 3 RADCLIFFE NEW ROAD WHITEFIELD MANCHESTER M45 7NR UK
TEL: +44 (0)161 767 1111 UK SALES DIRECT: +44 (0)161 767 1122 UK FAX: +44 (0)161 767 1128
EXPORT FAX: +44 (0)161 767 1166 E-MAIL: INFO@POLYFLOR.COM WWW.POLYFLOR.COM
UK SAMPLE REQUESTS: +44 (0)161 767 2551

James Halstead
FLOORING



2006

POLYFLOR
**POLYCLAD
PLUS**

WALL CLADDING

PERFORMANCE AND
PROPERTIES

POLYFLORTM
COVERING THE WORLD

SECTION 7

■ **Installation Instructions** Installation of Safety Vinyl Sheet

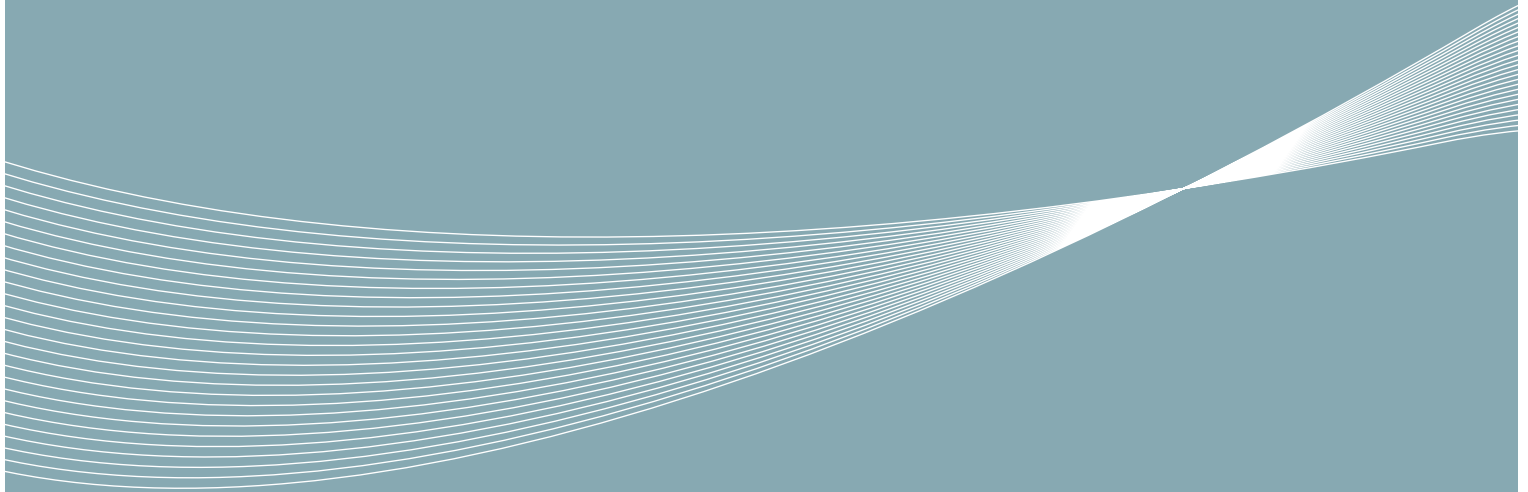

INSTALLATION OF HOMOGENEOUS & SAFETY VINYL SHEET

On receipt of rolls, check that colours correspond to those ordered, that quantities are correct and that there is no damage. In particular, check that rolls are from one batch, if that was requested on the order.

On arrival at site, the rolls should be safely secured in an upright position and stored, together with the adhesive, at a minimum temperature of 18°C for at least 24 hours before laying.

Inflammable adhesives require special storage conditions. Contact the adhesive manufacturer or see current literature for details.

To achieve best results, site conditions should be as described in BS 8203. A working temperature of between 18°C and 26°C is required for at least 24 hours prior to, and during, the laying period and for 24 hours afterwards. Conditioning areas and laying areas should be of similar temperature, to prevent thermally induced dimensional changes.

In installations where underfloor heating is used, this should be switched off from 48 hours prior to installation until 48 hours afterwards. It should then be slowly brought back up to the working temperature, a maximum of 27°C. Adhesives capable of withstanding temperatures up to 27°C should be used.

Where direct sunlight, sometimes in conjunction with underfloor heating, creates high surface temperatures on the floor, a high temperature grade of approved adhesive should be used.

The work area should now be prepared to receive the vinyl sheet flooring. Ensure that all other trades have

completed their work and removed all their equipment and materials. Remove all debris and sweep or vacuum the whole floor area. Check the condition of the subfloor and make good as necessary. Stone or power grind any cementitious subfloor to remove any "nibs" or ridges. Remove any surface contaminants, which may affect adhesion. Sweep or vacuum again prior to laying. If required by the contract, or if in doubt, check the moisture content of the subfloor and record the results and method used. Good lighting is essential.

It is important to note that commencement of work is deemed by many as acceptance of the site conditions as being suitable for laying floorcoverings.

1. LAYOUT OF VINYL SHEET

The architect may have provided a drawing showing the direction in which the material should be laid. In this case, lay the vinyl sheet as directed. If the architect has left this to the discretion of the flooring contractor, it is advisable to show at the tender stage in which direction the material will be laid and state that your estimate is based on this. Always pay particular attention to where seams will fall, avoiding such occurrences as seams in the centre of doorways. If large windows are installed, minimise the effect of the joints by laying towards the window.

2. SLABBING THE VINYL SHEET

Polyflor recommends that all Polyflor vinyl sheet flooring be rolled out face upward, taking care not to damage the surface, and cut approximately to size. Allowance of at least 75mm should be made at the

ends for trimming in. Ideally, the slabs should then be left overnight, and preferably for 24 hours, to condition at a minimum temperature of 18°C.

With Polytrede Acoustic PU and Polytrede Sport PU, a minimum conditioning period of at least 3 hours must be observed.

3. FITTING THE FIRST LENGTH

3.1 Non-foam backed products

Place the first sheet in position next to the wall with the outer edge approximately 15mm from the nearest point. Adjust the lie of the sheet so that the inner edge is parallel with the axis of the room (Figure 1).

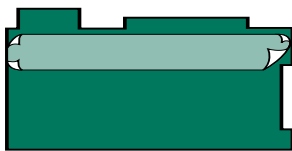

Figure 1 Lining up the first sheet

Depending upon the depth of the recesses, either a bar scriber or a pair of scribes should be used to trace the profile of the wall. The scribes should be set to allow for the deepest recess or rake of the wall. Holding the scribes vertically and square to the vinyl edge, trace the wall profile onto the face of the sheet (Figure 2). With this method, all irregularities of the wall will be accurately reproduced onto the surface of the vinyl sheet. If, because of the colour or decoration, the scribed line is difficult to see, rub suitably contrasting chalk dust into the line to highlight it.

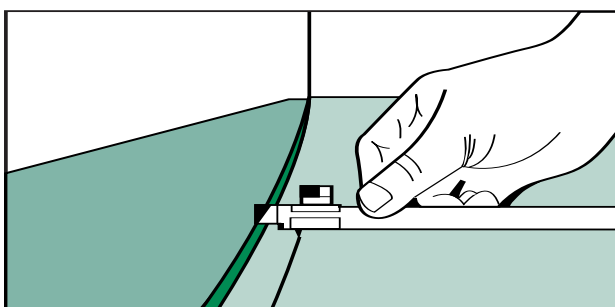

Figure 2 Scribing the wall profile

Ease the sheet away from the wall and, using a hook blade trimming knife, cut off the excess vinyl to the

scribed line. Slide the sheet back against the wall and check the fit, making any minor adjustments as necessary.

When satisfied that the fit on the first edge is correct, use a pencil to trace the opposite edge onto the subfloor (line A-B in Figure 3).

In the centre of the room, draw a line on both the vinyl and subfloor square to the main axis of the sheet (line C-D in Figure 3).

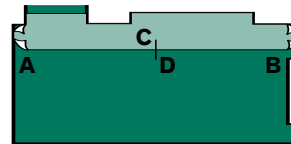

Figure 3 Marking the position

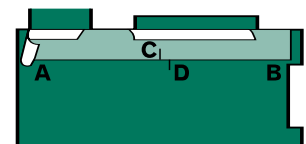

Figure 4 Moving the sheet clear

Keeping the inner edge of the vinyl on line A-B, slide the sheet back to clear the wall at one end of the room (Figure 4).

Set the scribes to the distance now between lines C and D (Figure 5). Trace the end wall profile and cut to fit as described in preceding paragraphs.

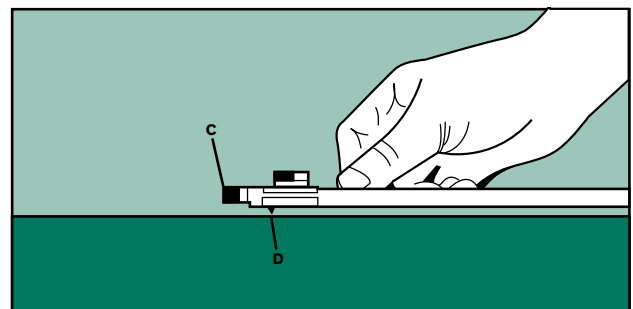

Figure 5 Setting the scriber

Repeat for the other end of the sheet. Once completed, the whole sheet - when slid back into position - should fit the wall profiles exactly.

Note: If fitting to set-in coving, the same principles apply but a reverse scriber must be used to trace the toe onto the sheet. It is normal to free hand cut to the coving, allowing 12mm overlap for final trimming in.

3.2 Foam backed products

Fit as in Figures 1 and 2 as described previously, but do not fit the ends of the room at this stage. See 6.2.

4. FITTING SUBSEQUENT LENGTHS

Place the second length parallel to the first length, with a maximum 25mm overlap along the adjoining edges. On the opposite side, trace the edge along the whole length onto the subfloor. In the middle, draw a line C-D at right angles to the main axis, as previously described.

Using the longitudinal line as a guide, slide back the sheet from the end wall and fit as described in Section 3.1. Repeat for the opposite end. Repeat the sequence for all remaining lengths. On the final length, which abuts the opposite wall, fit as described for the first length (Section 3.1).

5. CUTTING IN THE SEAMS

Polyflor recommends that all Polyflor vinyl sheet floorcoverings are welded. Seam cutting, grooving and heat welding are described in detail in the section Welding Vinyl Flooring.

Note: The seams should be cut before the adhesive is spread.

6. ADHERING THE VINYL SHEET

Prior to adhering the vinyl sheet, it is important to read and understand the adhesive manufacturer's instructions, recommendations and safety advice. You need to know the hazards and limitations of the adhesive, especially the open time.

Never spread more adhesive than can be laid within the open time. Polyflor does not recommend any method of adhesive application, such as rolling or spraying, which cannot guarantee the spread rate.

6.1 Wet set adhesives

Wherever practical, start with central strips first, as these are usually easier, having fewer recesses or awkward fittings.

A

Fold back the sheet to just over half its length, making sure the remaining half retains its position.

B

Spread the adhesive using a notched trowel of the correct size, as recommended by the adhesive manufacturer. Maintain the correct size of notch at all times, recutting as necessary as work progresses.

C

When the adhesive is ready to accept the floorcovering, roll the vinyl sheet back into place, taking care not to twist the roll or trap air bubbles.

D

Check that seams are without gaps and remove any excess adhesive.

E

Roll with a 68kg articulated floor roller, firstly in the short direction, then in the long. In corners and other awkward areas, use a hand roller.

F

Repeat over the whole floor until all the sheets are adhered.

G

Roll the whole area thoroughly again, between one and four hours later.

6.2 Adhering foam-backed vinyl sheet

After fitting the vinyl as in Figures 1 and 2, Section 3.1, fold back the sheet to just over half its length, making sure the remaining half retains its position. Spread the adhesive until approximately 1 linear metre away from the end of the room. When the adhesive is ready to accept the floorcovering, roll the vinyl sheet back into place, taking care not to twist the roll or trap air bubbles. Repeat the process for the other half of the length. The adhered vinyl can then be rolled.

The first end of the room can now be fitted. Mark the line C-D (see Figure 3) across the seam, approximately 300mm from the wall to be fitted. Slide back the sheet, ensuring that it is butted up to the

adjacent length and set the scribes to the distance between points C and D.

Trace the end wall profile and cut and fit as described in preceding paragraphs. Repeat for the other end.

The last sections of material can now be adhered and rolled.

Note 1: When laying onto dense, non-porous subfloors, the double drop technique as described in the 'Electro Static Dissipative Floorcoverings' pdf is recommended, to achieve maximum transfer of adhesive and initial bond strength. This technique should always be used for Polytréd Acoustic and Polytréd Sport.

Note 2: Polyflor does not recommend any method of adhesive application, such as rolling or spraying, which cannot guarantee the spread rate.

6.3 Premature trafficking of newly laid floors

Early trafficking may disturb the adhesive bond and weaken it, resulting in the associated problems of tracking, indentation, debonding etc. After the vinyl sheet has been installed, only light foot traffic should be allowed for at least 24 hours. Where liable to be subject to heavy trafficking, the vinyl should be protected with hardboard or plywood for at least 48 hours.

6.4 Pressure-sensitive adhesives

These adhesives are designed to go completely dry prior to laying into and are particularly well suited to dense subfloors where there is difficulty with moisture uptake. They have the advantage of very long open times but, because they are laid into dry, have the disadvantage that the adhesive ridges are not flattened when the vinyl is rolled. To eliminate this disadvantage, Polyflor recommends an alternative method of application:

A

Fold back all the sheets to just over half their length.

B

Spread the adhesive with the correct notch trowel. Maintain the correct size of notch at all times. Then roll out the adhesive ridges with a long handled, short pile adhesive roller.

Note: To maintain the correct spread rate, the adhesive roller should be pre-wetted with adhesive. This will prevent it taking adhesive from the floor.

C

Wrap the roller in a polyethylene bag and hang up when not in use. This will prevent it from drying out. It also prevents flats being formed and avoids regular washing out and pre-wetting.

D

When the adhesive is completely dry and ready to lay into, it will change from opaque to clear or translucent. The adhesive will be tacky to the touch. It is worth remembering that air flow is the most critical factor in the drying time and not temperature. Electric fans can be used to accelerate the drying time.

E

Place a length of 100mm wide polyethylene strip onto the edge of the adhesive adjacent to the fold in the vinyl sheet (Figure 6). This will prevent the sheet sticking to the last 100mm of adhesive.

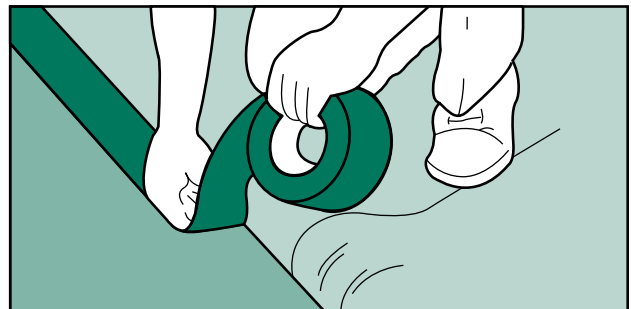

Figure 6 Polyethylene strip

F

Roll the central sheet back into place along the longitudinal line, taking care not to twist the roll or trap air bubbles. (A length of wide polyethylene strip can be rolled out on top of the adhesive to enable it to be walked on. This can be helpful when fitting the first length up to the line. Roll it up from the far end on completion.)

G

Fit all the other sheets, working outwards from the central sheet, as described previously. Take extra care to ensure that seams are without gaps and remove any excess adhesive as work proceeds.

H

Fold back the second halves of the vinyl sheets and remove the polyethylene strip which was stuck to the edge of the adhesive. Repeat sequence of adhering vinyl sheet as described previously.

I

Roll thoroughly in both directions using a 68kg articulated floor roller. In corners and other awkward areas, use a hand roller.

7. PATTERN TEMPLATE METHOD

Areas which call for a considerable amount of fitting around obstacles, or which are too confined to lay down a sheet for fitting by normal methods, can be dealt with by templating the floor in felt paper.

Note: In new buildings, it may be worthwhile discussing installation with the main contractor who may agree to fitting WCs, sinks etc. after the vinyl has been laid.

A

Dry fit the area with felt paper, leaving a gap of 15mm to 20mm around obstructions.

B

Draw around the fittings using a compass set at 25mm. Mark the template "This Side Up".

C

Place the vinyl sheet in a larger area with the face uppermost. Place the template on top ensuring the direction of decoration is correct. Secure the template firmly in position and, with a pair of scribes set at 25mm, mark the position of all obstacles using the template as a guide.

D

Using a sharp vinyl trimming knife, cut the vinyl sheet to the scribed lines and fit into position.

Note: Do not use the felt paper template as an underlay.

8. SITE FORMED COVERED SKIRTINGS

Polyflor fully flexible vinyl flooring, in conjunction with Polyflor Ejecta cove former (see also Installation of Accessories) can be used to create site formed covered skirting. In shower areas, for example, the vinyl sheet can be extended up the wall and, when welded, will form a watertight base. Alternatively, in hospital corridors or office complexes, a contrasting colour can be used for decoration or identification.

A

Adhere the sections of cove former using a contact adhesive. Use a mitre-block to accurately cut internal and external

corners and only adjust for length on straight cuts.

Note: The installation of Polyflor Ejecta vinyl flooring accessories using contact adhesives is covered in detail in the section Installation of Accessories .

B

To prevent a difficult fit, and potential weak spot near doorways, cut away the back edge of the cove former on a taper for 150mm (Figure 7) so that there is minimal cove former near the doorway (Figure 8). Heating the cove former will enable the shape to be formed but do not use a

naked flame.

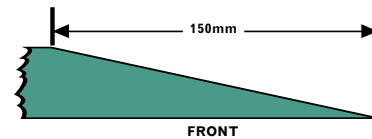

Figure 7 Tapering the cove former

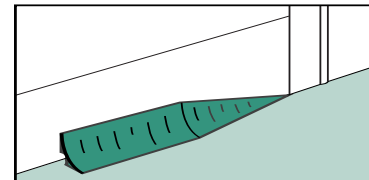

Figure 8 Taper towards a doorway

8.1 Fitting with clip-in capping strip (type CS-N)

A

Using a height gauge fitted with a pencil, draw a line on the walls around the room to the height the coving will reach.

B

Reduce the height gauge to allow for the thickness of the floorcovering and adhesive. Fit the vinyl to the walls and then draw a line to the same height as previous. Using a straight edge and sharp knife, trim off the excess.

C

Pull back the sheet from the walls. Fit the capping strip to the wall with contact adhesive so that the top of the sheet will sit inside the cap.

D

Apply contact adhesive to the face of the cove former and upto the capping strip. Coat the back of the vinyl with contact adhesive and leave both to dry.

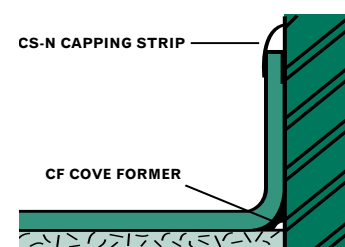

Figure 9 CS-N capping strip

E

When dry, push the vinyl into place and tuck the top edge into the capping strip (Figure 9). Roll with a hand roller to ensure even contact.

8.2 Fitting with sit-on capping strip (Type CS)

A

Using a height gauge fitted with a pencil, draw a line on the walls around the room to the height the coving will reach.

B

Apply contact adhesive to the face of the cove former and up to the pencil line on the wall. Coat the back of the vinyl with contact adhesive and leave both to dry.

C

When dry, push the vinyl into place and roll with a hand roller to ensure even contact.

D

Reduce the height gauge to allow for the thickness of the floorcovering and adhesive. Draw a line on the vinyl to the same height as previous. Using a straight edge and sharp knife, trim off the excess.

E

Using a piece of capping strip, mark where the strip overlaps the wall and vinyl sheet. Apply contact adhesive between the lines and to the back of the capping strip. When dry, push into place (Figure 10).

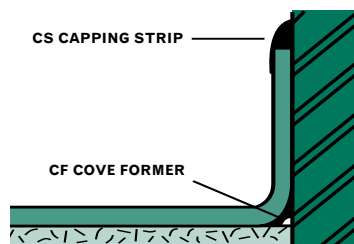

Figure 10 CS capping strip

Note: Welded external corners are prone to breaking open due to damage from wheeled traffic. To prevent this from occurring, and as an alternative to the traditional mitre, the joint may be cut at an angle and taken around the corner and welded (Figure 11).

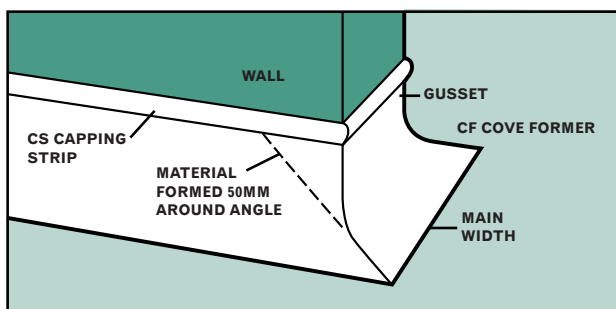

Figure 11 External corners

9. FITTING TO CERAMIC WALL TILES

For the junction between site formed coved skirting and ceramic wall tiles, Polyflor Ejecta CT strip should be used. The flexible section is designed to accept

ceramic tiles on one side and various gauges of vinyl on the other.

The Polyflor CT strip should be adhered using a contact adhesive as recommended by Polyflor.

The edge between the CT strip and the ceramic tiles should be grouted. The Polyflor should be fitted into the bottom edge of the CT strip and adhered to the wall using a contact adhesive as recommended by Polyflor. See also section on Recommended Finishes. A thin bead of mastic sealant should be run along the underside edge of the CT strip and the Polyflor (Figure 12).

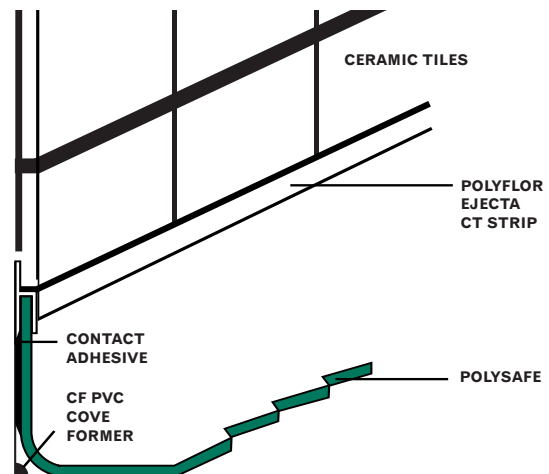
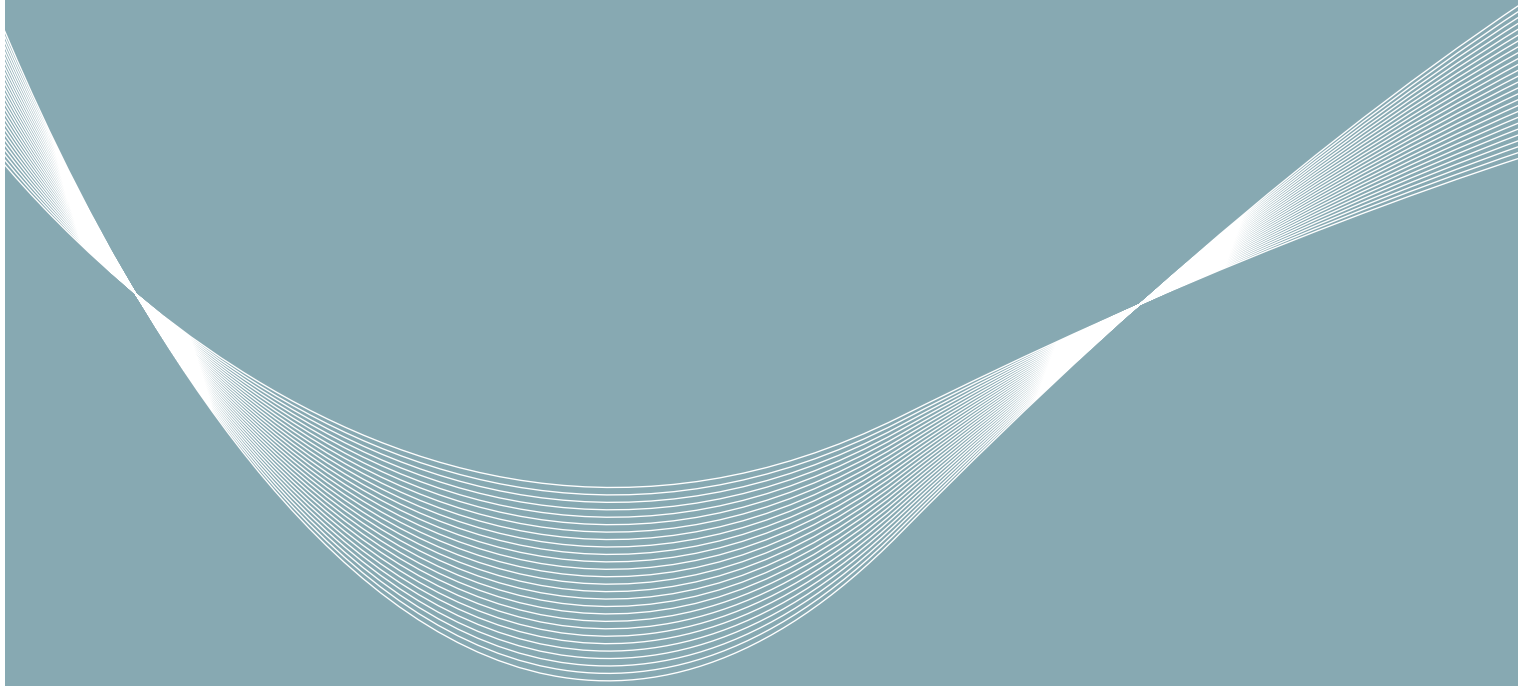

Figure 12 Fitting to ceramic tiles

- **Floor & Wall Care Instructions**



**INITIAL CONSTRUCTION CLEAN**

- Sweep, mop sweep or dry vacuum the floor to remove dust, grit and debris.
- Apply a solution of alkaline cleanser, diluted to the manufacturer's instructions, to the floor and leave for sufficient time to react with the soiling. Using a 165 rpm rotary machine fitted with a rotary scrubbing brush or, if necessary, a scrubbing pad, machine scrub the floor and then pick up the slurry with a wet vacuum. Rinse the floor thoroughly with clean, warm water, pick up with a wet vacuum and leave to dry thoroughly.
- **Note 1:** For small areas, where there is no suitable scrubbing machine available, a deck scrubber should be used in conjunction with a wet vacuum or mop and bucket system.
- **Note 2:** For very heavy soiling, dilution rates above the manufacturer's minimum recommendations may be necessary.
- **Note 3:** For Polysafe Hydro, the scrubbing pad should be replaced with a rotary scrubbing brush or a cylindrical type scrubbing machine.

**ROUTINE MAINTENANCE**

- The frequency of each of the operations is dependent upon the type and intensity of traffic.

STANDARD SURFACE FINISH

- Sweep, mop sweep or dry vacuum the floor to remove dust and loose dirt.
- Spot mop regularly. Stubborn black marks can be removed by using the centre disc of a scrubbing pad and a small amount of undiluted alkaline cleanser. Place the disc under the sole of a shoe and rub - this gives greater pressure. Rinse the area well with clean warm water and leave to dry.
- Apply a solution of neutral or alkaline cleanser, diluted to the manufacturer's instructions, to the floor and leave for sufficient time to react with the soiling. Using a 165 rpm rotary machine fitted with a rotary scrubbing brush or, if necessary, a scrubbing pad, machine scrub the floor and then pick up the slurry with a wet vacuum. Rinse thoroughly with clean, warm water, pick up with a wet vacuum and leave to dry thoroughly.

POLYSAFE HYDRO

- Sweep, mop sweep or dry vacuum the floor to remove dust and loose dirt.
- Spot scrub regularly with a deck scrubber.
- Apply a solution of neutral or alkaline cleanser, diluted to the manufacturer's instructions, to the floor and leave for sufficient time to react with the soiling. Using a 165 rpm rotary machine fitted with a bristle brush, cylindrical machine or deck scrubber, scrub the floor and then pick up the slurry with a wet vacuum. Rinse thoroughly with clean, warm water, pick up with a wet vacuum and leave to dry thoroughly.

**APPLICATION OF A FLOOR DRESSING**

- A floor dressing or maintainer containing polish should not be applied to the Polysafe range, as this may impair the slip resistance but, if in doubt, consult our Technical Support staff.



- Always follow the Health and Safety guidance provided.
REGULAR CLEANING IS MORE BENEFICIAL TO THE FLOORCOVERING AND MORE COST-EFFECTIVE THAN OCCASIONAL HEAVY CLEANING.
- Cleaners and detergents should be diluted as per the manufacturers' instructions. For recommended products, see the Polyflor Approved Maintenance Products sheet located within the Technical section of www.polyflor.com.
- For further information and advice on specific applications, consult Polyflor Customer Technical Services on +44 (0)161 767 1912, or email tech@polyflor.com.

POLYFLOR
POLYSAFE™

SAFETY FLOORING

FLOORCARE FOR
POLYSAFE STANDARD,
STRATA
VOGUE ULTRA,
ULTIMA
AND HYDRO.



- For light soiling wipe the walls with a damp cloth, using a neutral cleanser diluted to the manufacturer's instructions.
- For heavy cleaning, use an alkaline cleanser diluted to the manufacturer's instructions. For stubborn marks use a deck scrubber, scrubbing brush or doodle bug. Wipe the walls with a damp cloth, using clean water and a small amount of neutralising agent such as acetic acid.



- Under most circumstances, the wall will not require a sealer coat of polish. If, however, it is felt necessary to either provide a protective finish or minimise maintenance, a matt finish metallised polish should be applied.
- Using a damp cloth the polish should be applied to a previously cleaned surface, as described in the previous section, in an even coat. Do not over-apply, to avoid runs in the polish.



- The frequency is dependent upon the rate of soiling.
- If lightly soiled wipe the walls with a damp cloth, using a neutral cleanser diluted to the manufacturer's instructions.
- If heavily soiled, especially with grease, wipe the walls with a damp cloth, using an alkaline cleanser diluted to the manufacturer's instructions. Afterwards rinse the walls, using clean warm water and a small amount of neutralising agent such as acetic acid.



- Should the dressing have to be removed a polish stripper, diluted to the manufacturer's instructions, should be applied to a small section at a time, using a wet cloth. The stripping solution should be left on the wall for almost 10 minutes and the surface should then be agitated using a deck scrubber, scrubbing brush, or doodle bug which has been pre-wetted in the solution.
- Once complete, the walls should be rinsed using a damp cloth and warm water and a small amount of neutralising agent such as acetic acid.
- Once the whole room has been stripped, a new coat of polish can be applied as described above.
- DO NOT USE STRONG KITCHEN DEGREASERS ON VINYL SURFACES.**



- Always follow the Health and Safety guidance provided.
- At the date of issue the data presented is correct. However, Polyflor Ltd. reserve the right to make changes which do not adversely affect performance or quality.
- Cleaners and detergents should be diluted as per the manufacturer's instructions. For recommended products, see the Polyflor Approved Maintenance Products sheet located within the Technical section of www.polyflor.com.
- REGULAR CLEANING IS MORE BENEFICIAL TO THE WALLCOVERING AND MORE COST-EFFECTIVE THAN OCCASIONAL HEAVY CLEANING.**
- For further information and advice on specific applications, consult Polyflor Customer Technical Services on +44 (0)161 767 1912, or email tech@polyflor.com.

POLYFLOR
POLYCLAD P_u
POLYCLAD PLUS P_u

WALL CLADDING

WALLCARE

